

A	B	C1	C2	C3	D
1	S504-0030	604	596	16	2/2
2	S504-1043	1870	390	15	1/2
3	S504-1044	1870	390	15	1/2
4	S504-2003	600	390	15	1/2
5	S504-2004	600	390	15	1/2
6	S504-3016	569	360	15	1/2
7	S504-3017	568	360	15	1/2
8	S504-3018	562	340	4	2/2
9	S504-3022	569	354	15	1/2
10	S504-5554	746	564	3	2/2
11	S504-7314	403	596	16	2/2
12	S504-7322	200	596	16	2/2
13	S504-9308	1880	579	2,5	1/2
14	qc33\1				1/2
15	S504-5702	569	68	16	2/2
16	S504-4033	569	68	15	2/2

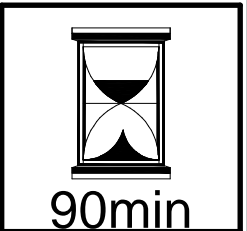

5x a102	5x b59	4x d1	4x d38	2x d41\2	4x e1	6x e47	20x f1	18x l1	18x l2	4x k27	6x o54	10x p38
10x p51	16x r1	16x r42	10x s4	5x s71	12x s2	1x z1	2x f35	2x n14\2	2x p17	4x p38		

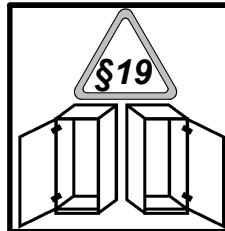

1 

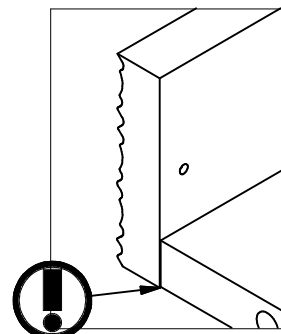
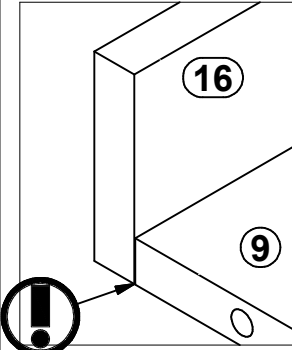
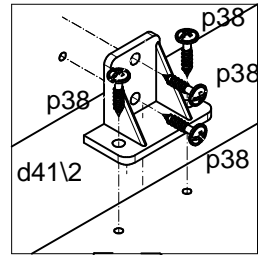
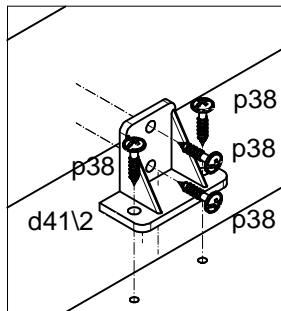
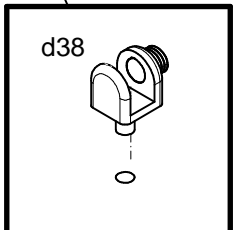
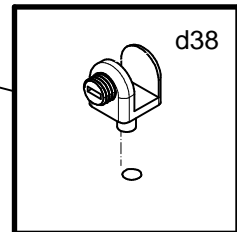
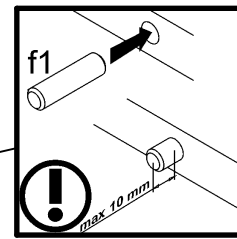
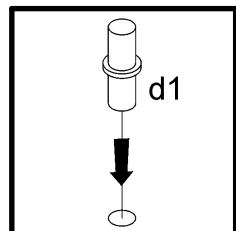
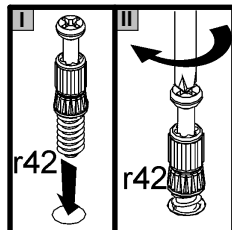
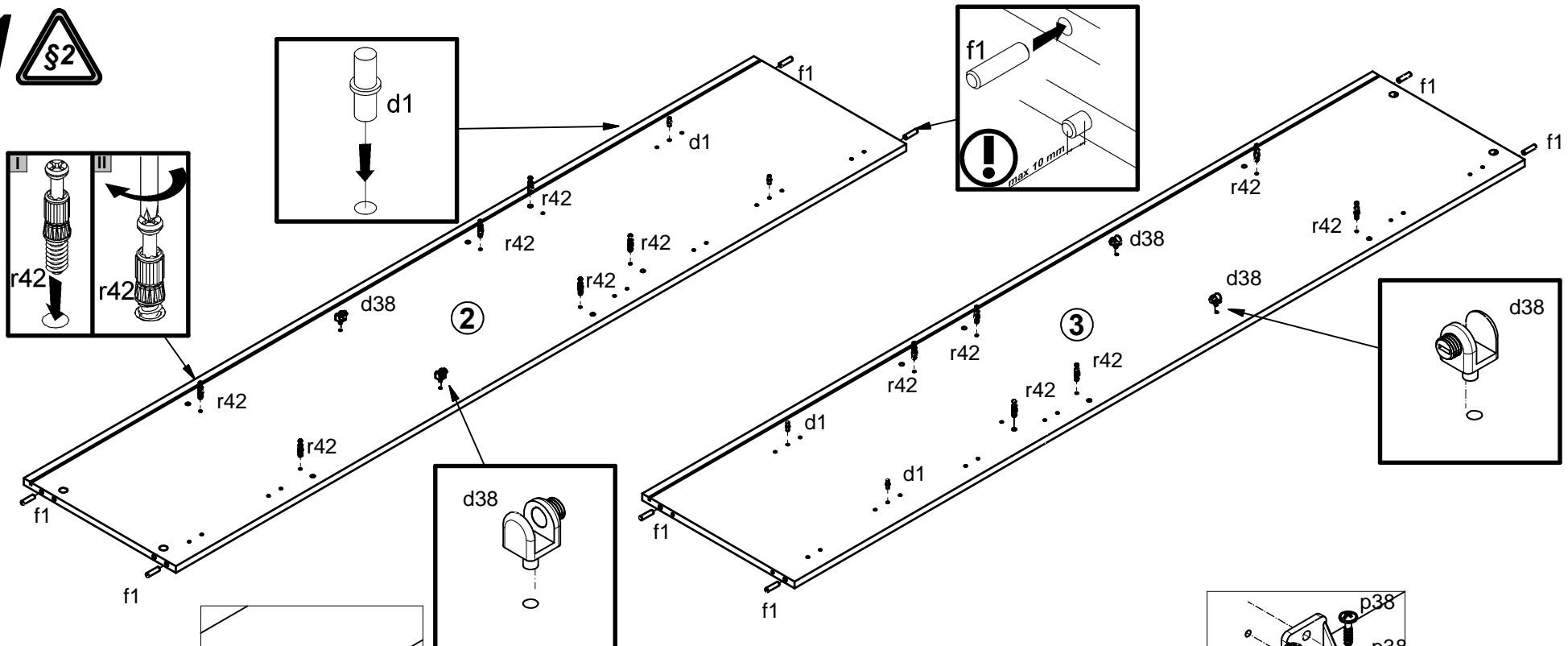

 §14

1

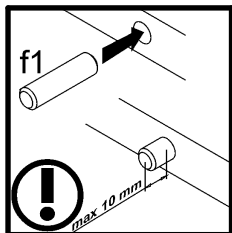

2

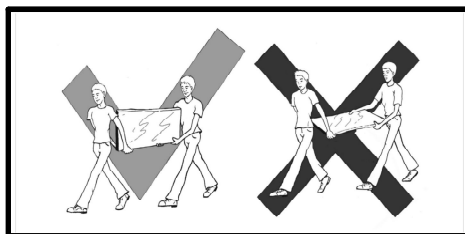
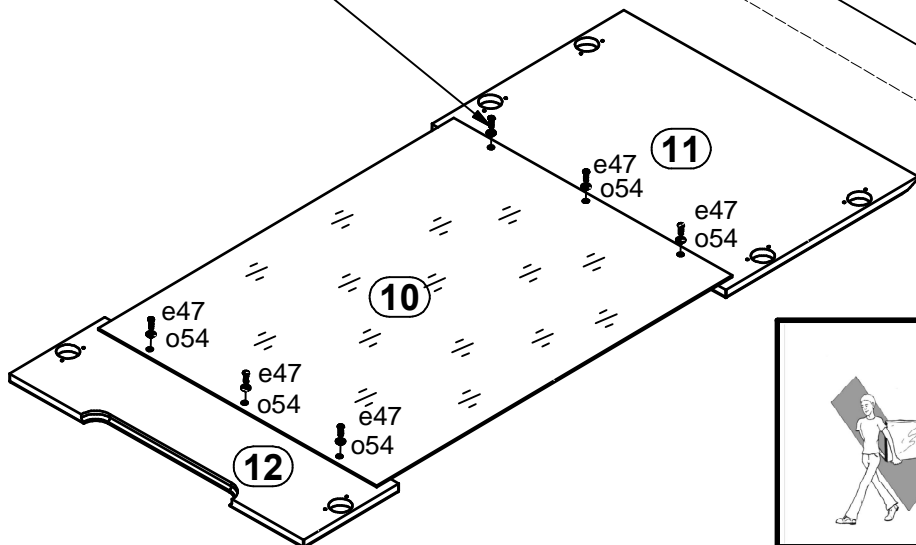
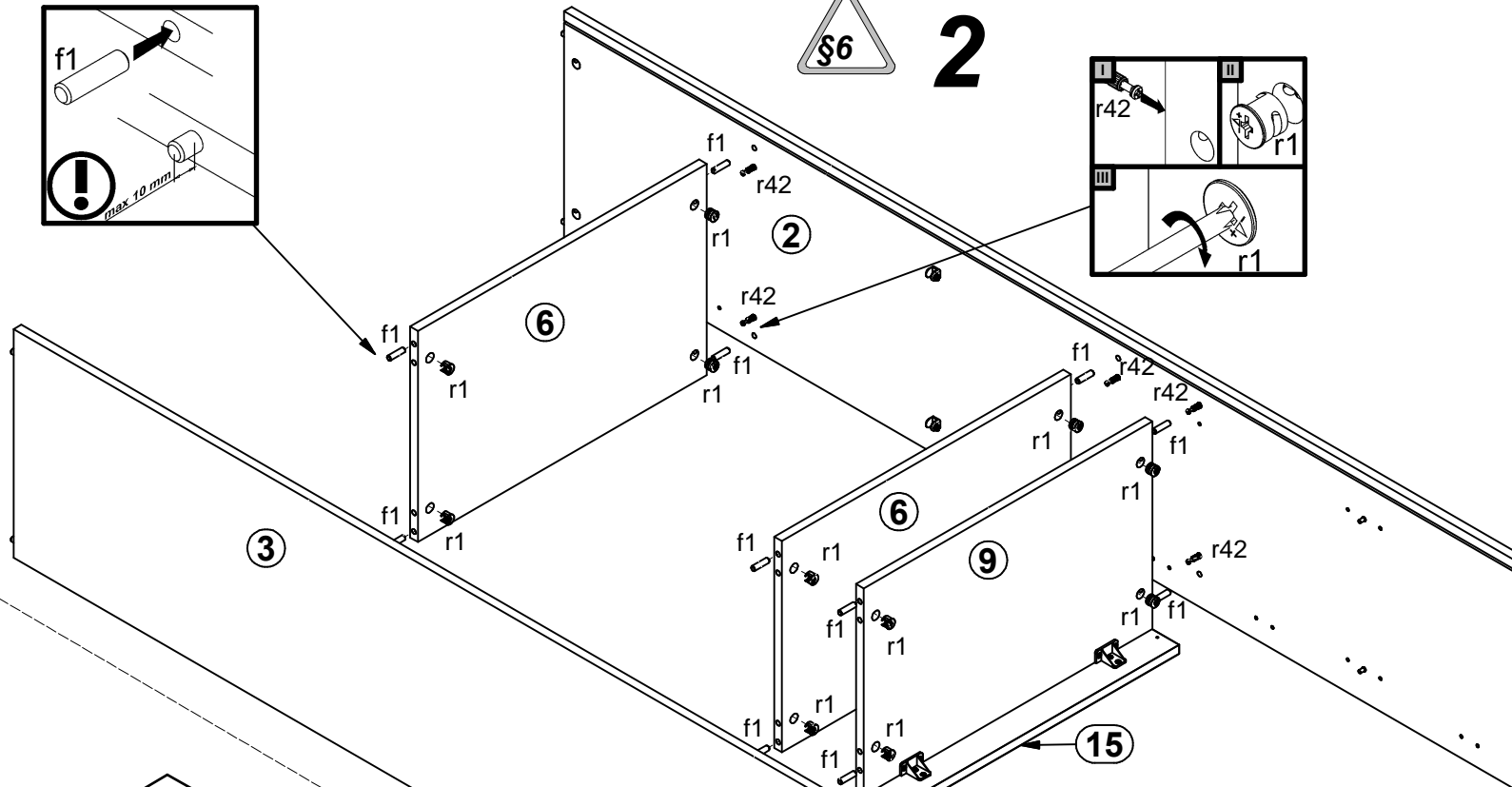
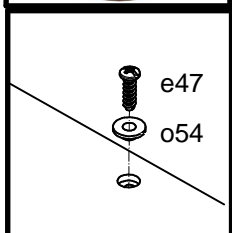
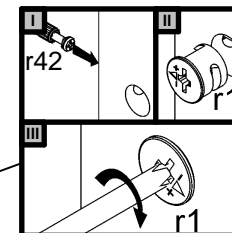

3

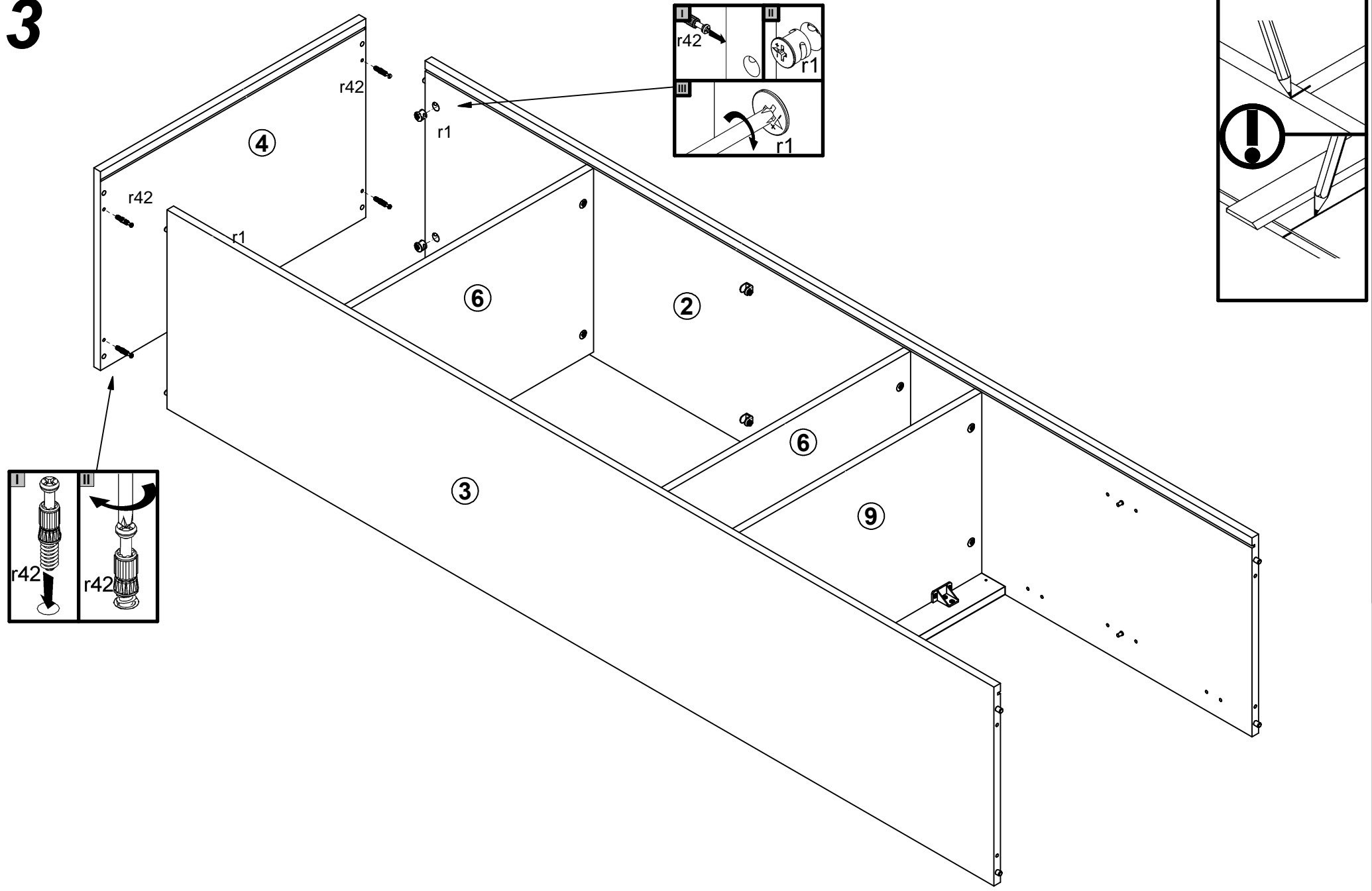

5

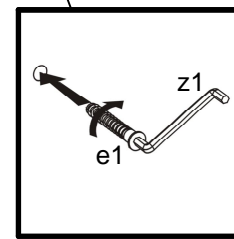
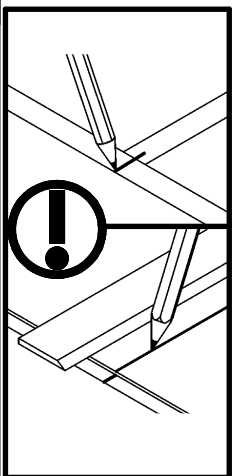
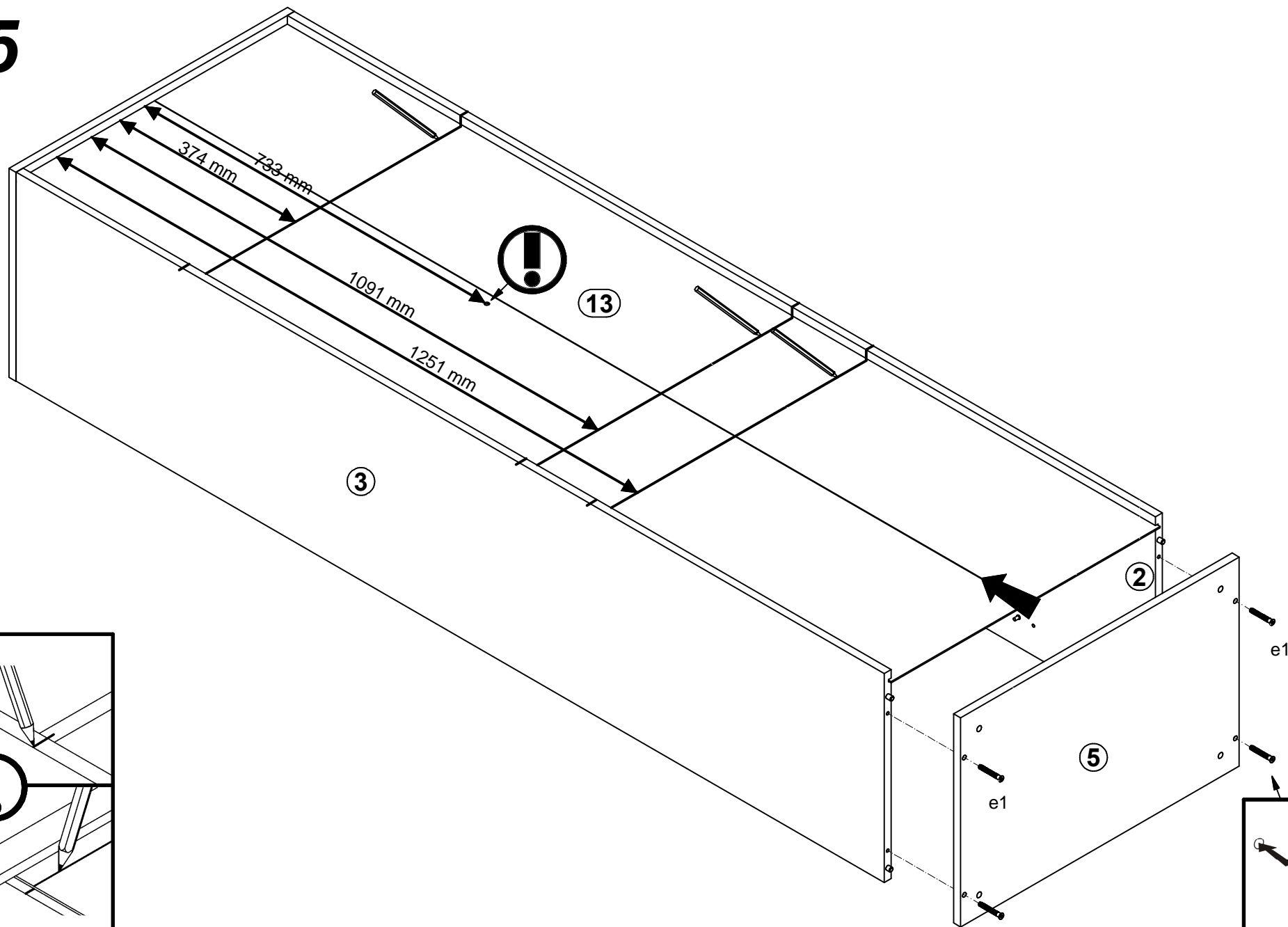

6

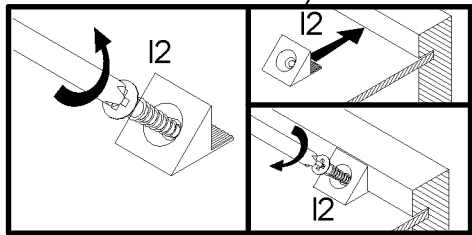
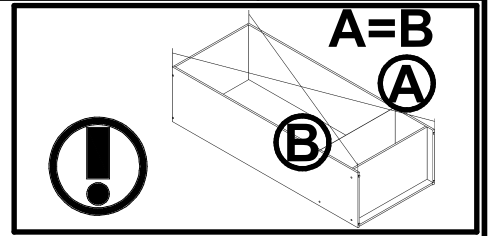
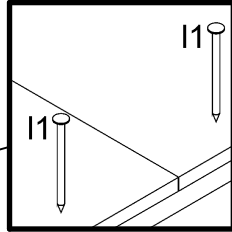
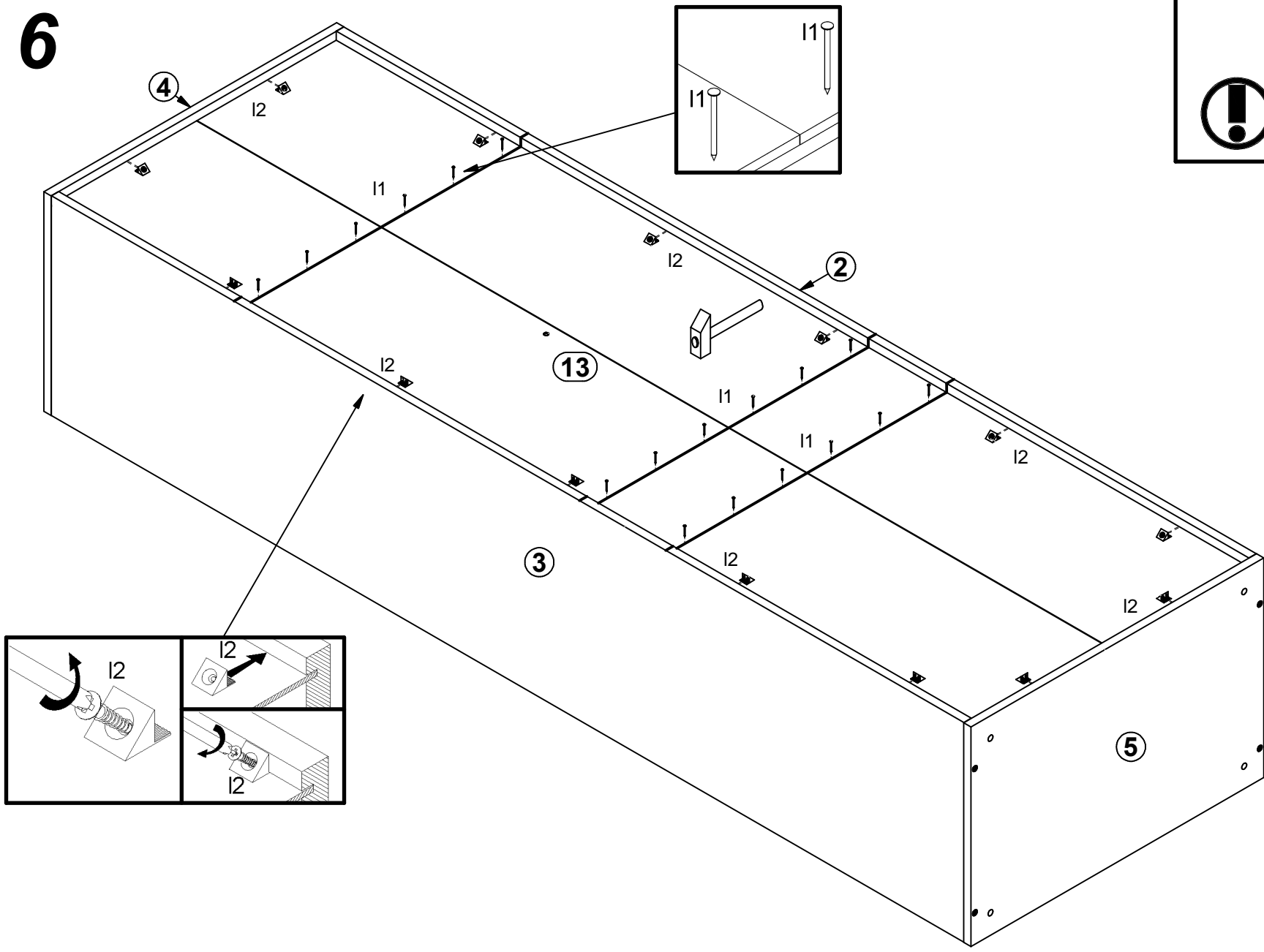

6

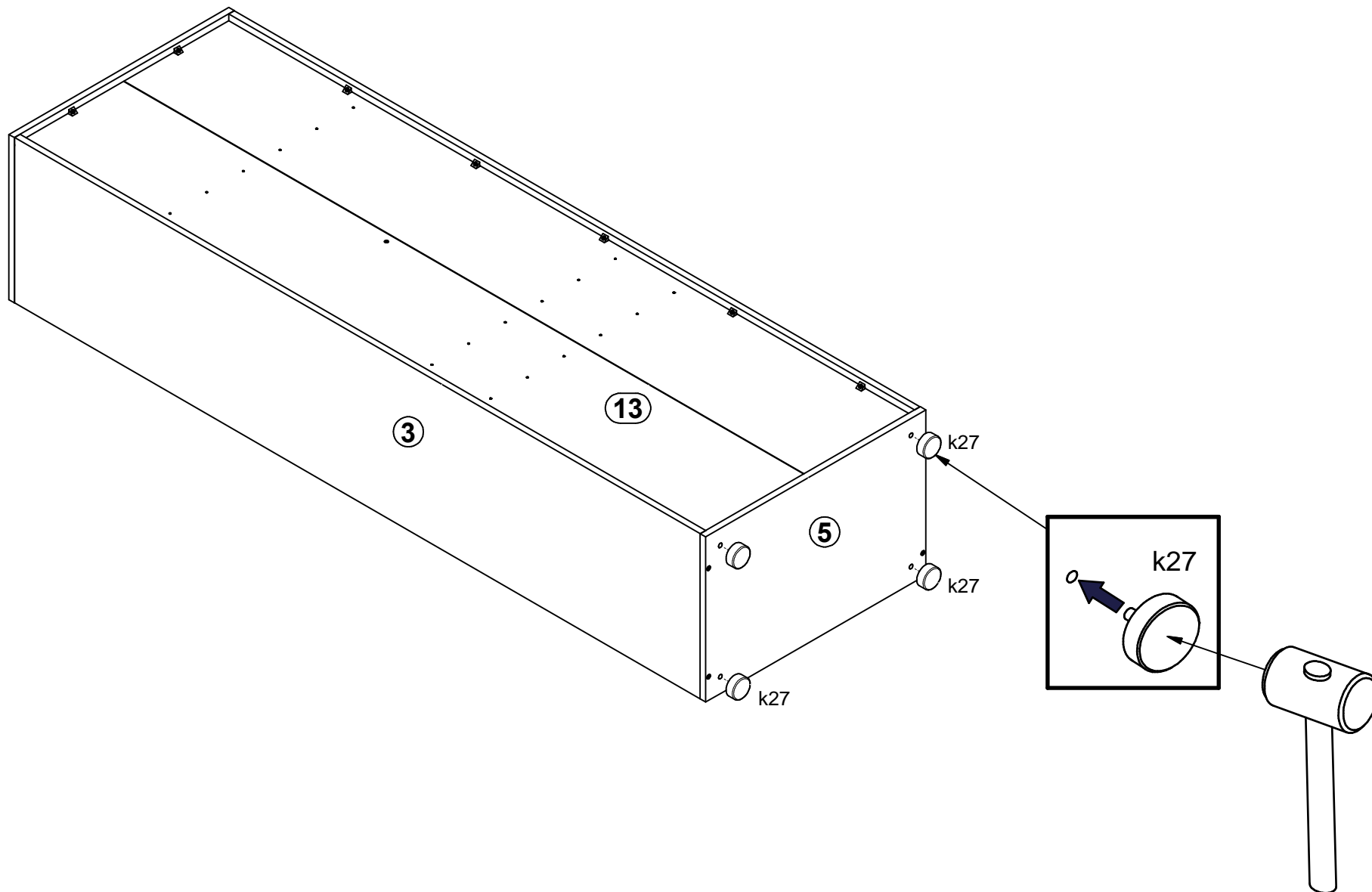

7

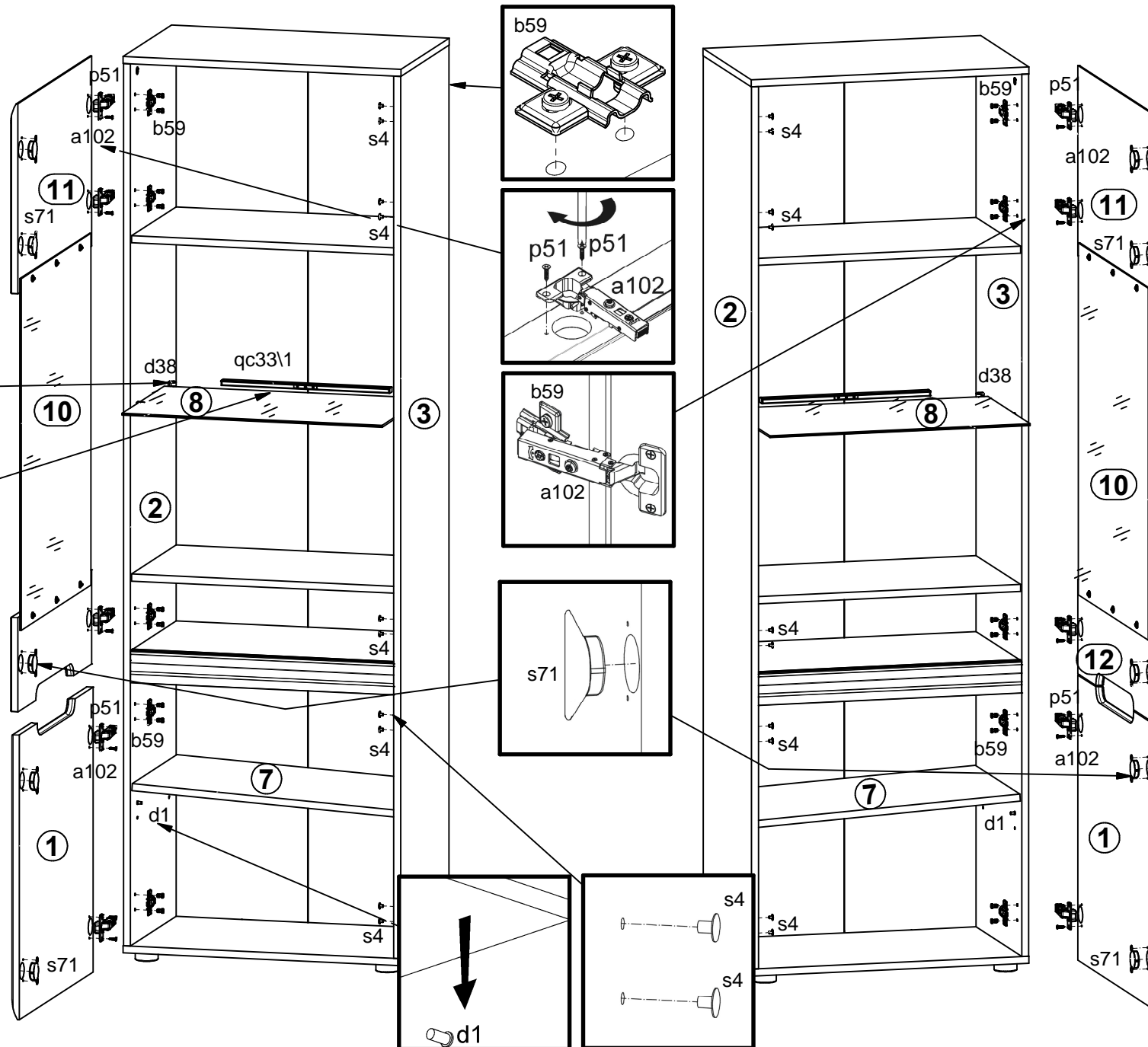
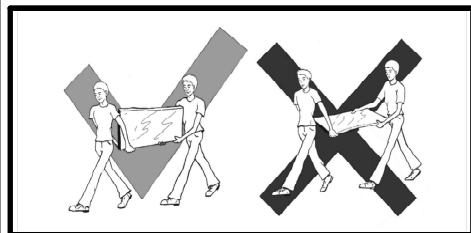
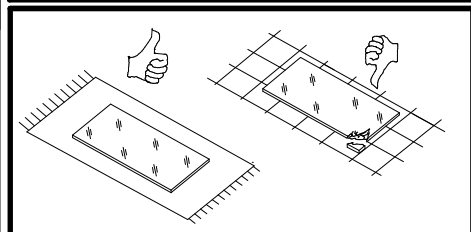
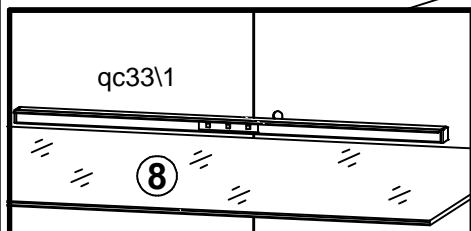
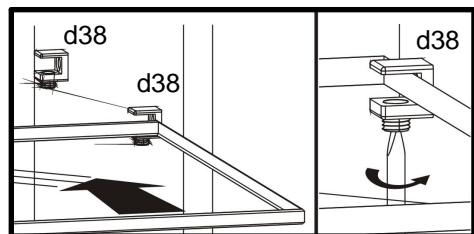
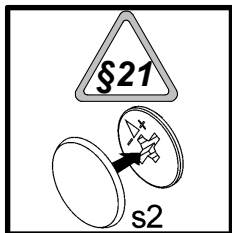
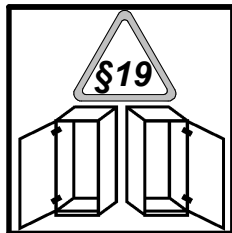

8

