

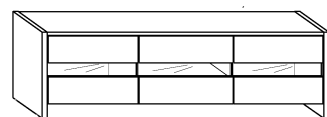

# FOX

→ 139 ↑ 42 ↘ 36



|              |              |               |                           |                         |              |               |              |
|--------------|--------------|---------------|---------------------------|-------------------------|--------------|---------------|--------------|
| x 6<br><br>a | x 4<br><br>b | x 12<br><br>c | x 12<br><br>d             | x 2<br><br>e            | x 4<br><br>f | x 6<br><br>g  | x 3<br><br>h |
| x 3<br><br>i | x 4<br><br>j | x 18<br><br>k | x 16<br>(3,5x16)<br><br>n | x 18<br>(3x20)<br><br>o | x 4<br><br>p | x 60<br><br>r | x 1<br><br>s |
| x 2<br><br>l |              |               |                           | <br>m                   |              |               |              |



① - FAZY MONTAŻU

Ⓐ - OZNACZENIE ELEMENTÓW

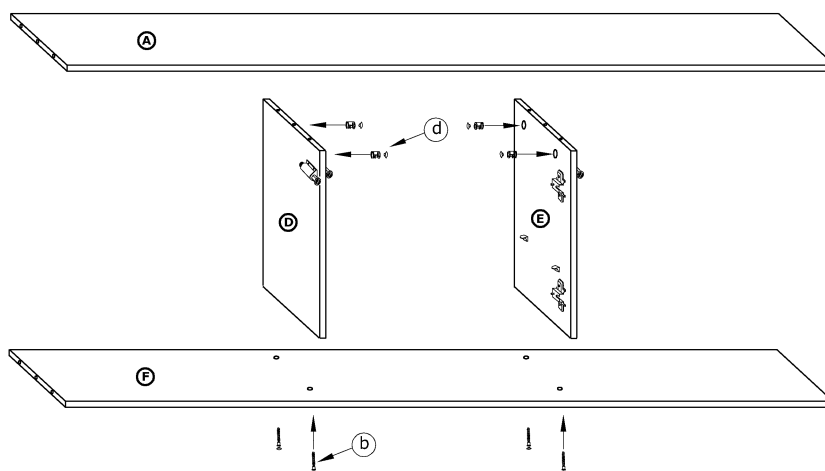
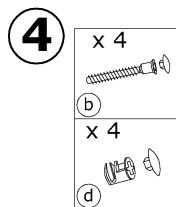
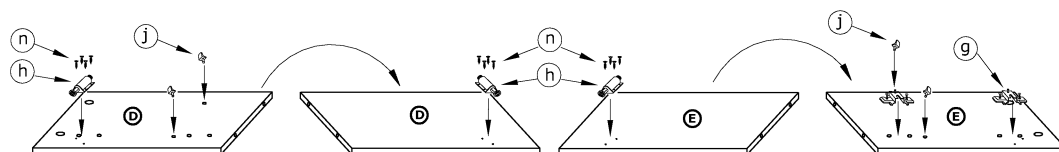
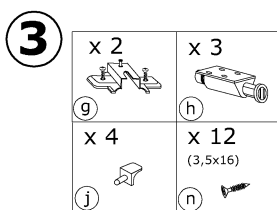
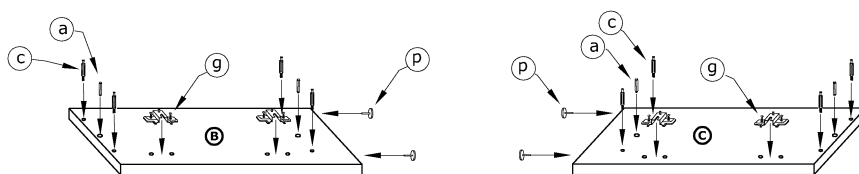
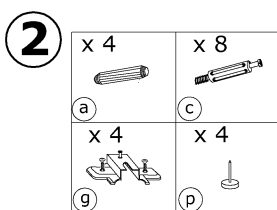
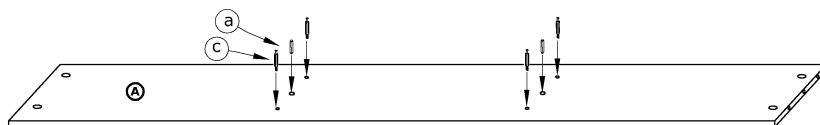
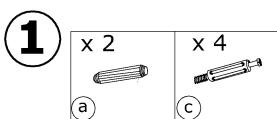
Ⓐ - OZNACZENIE AKCESORIÓW



5

- x 8  

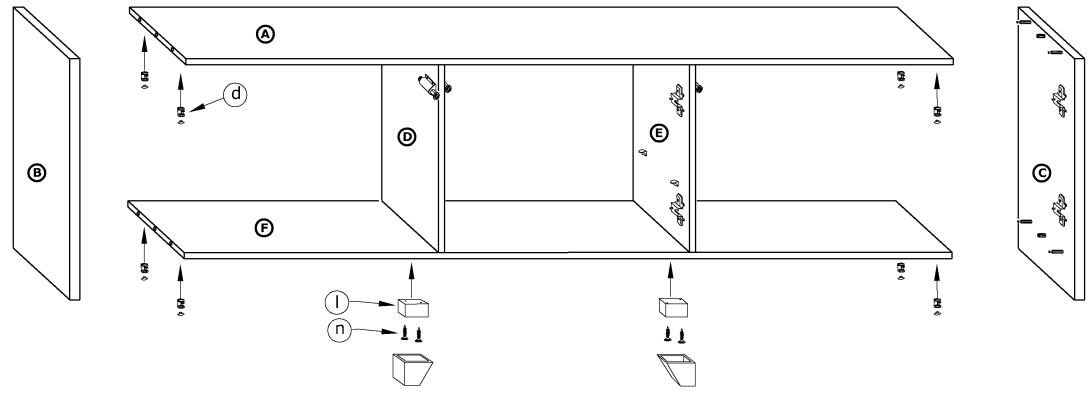
- x 2  

- x 4  
(3,5x16)  



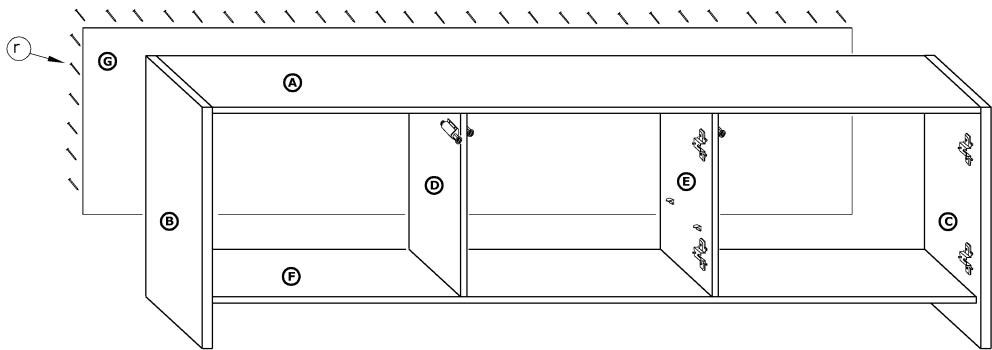





6

- x 60  



7

- |   |   |  |
|---|---|--|
| x 2<br>            | x 4<br>              | x 3<br> |
| x 18<br>           | x 18<br>(3,5x16)<br> |  |
| x 18<br>(3x20)<br> |   |  |

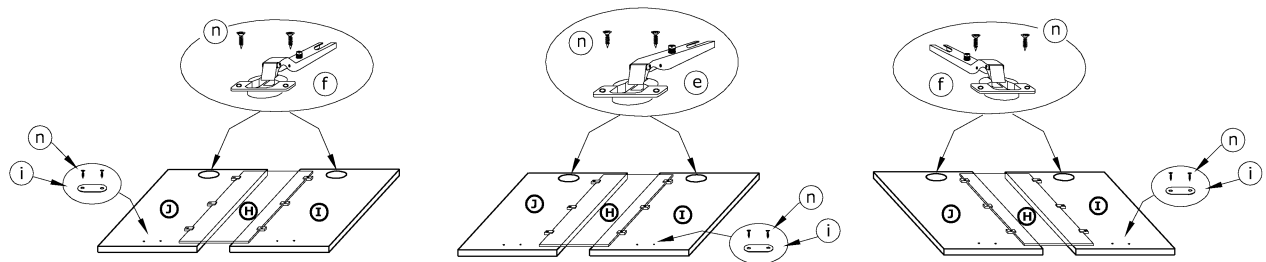
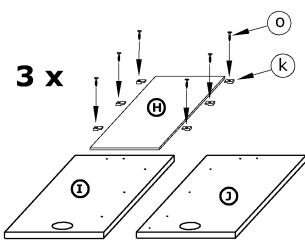

8

